

## Change motor's direction:

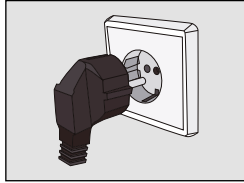

**01** • Continuously press the **CLOSE** key transmitter to be programmed.



**02** • Connect the control board to a 230V power supply.



**03** • Keep the **CLOSE** key pressed for 10 seconds, during which the control board emits slow 5 beeps.



**04** • After 10 sec, the control board emits 2 quick beeps confirming the programming success.

## Erase the controllers from the control board's memory:

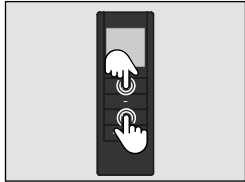

**01** • Continuously press the **OPEN** and **CLOSE** key transmitter to be programmed.

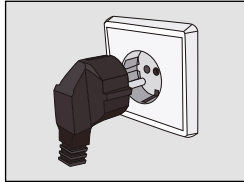

**02** • Connect the control board to a 230V power supply.



**03** • Keep the **OPEN** and **CLOSE** key pressed for 10 seconds, during which the control board emits slow 5 beeps.



**04** • After 10 sec, the control board emits 2 quick beeps confirming the programming success.

## SAFETY INSTRUCTIONS

### ATTENTION:

#### Importance of the Manual:

- It is important for your safety that these instructions are followed.
- Keep these instructions in a safe place for future reference.

#### Responsibility:

- The **ELECTROCELOS S.A.** is not responsible for the improper use of the product, or other use than that for which it was designed.
- The **ELECTROCELOS S.A.** is not responsible if safety standards were not taken into account when installing the equipment, or for any deformation that may occur.
- The **ELECTROCELOS S.A.** is not responsible for insecurity and malfunction of the product when used with components that were not sold by the themselves.

#### Mechanism use:

- This product was designed and manufactured strictly for the use indicated in this manual. This control board is not appropriate for inflammable or explosive environments. Any other use not expressly indicated may damage the product and/or can cause physical and property damages, and will void the warranty. Do not make any changes to the automation components and/or their accessories. Central for indoor use with 230V connection. Keep remote controls away from children, to prevent the automated system from being activated involuntarily. The customer shall not, under any circumstances, attempt to repair or tune the automation. Must call qualified technician only.

#### To Installer:

- The installer must have certified professional knowledge at the level of mechanical assemblies in doors and gates and control board programming. He should also be able to perform electrical connections in compliance with all applicable regulations.
- The installer should inform the customer how to handle the product in an emergency and provide him the manual.



This control board was designed with the purpose of programming tubular motors.

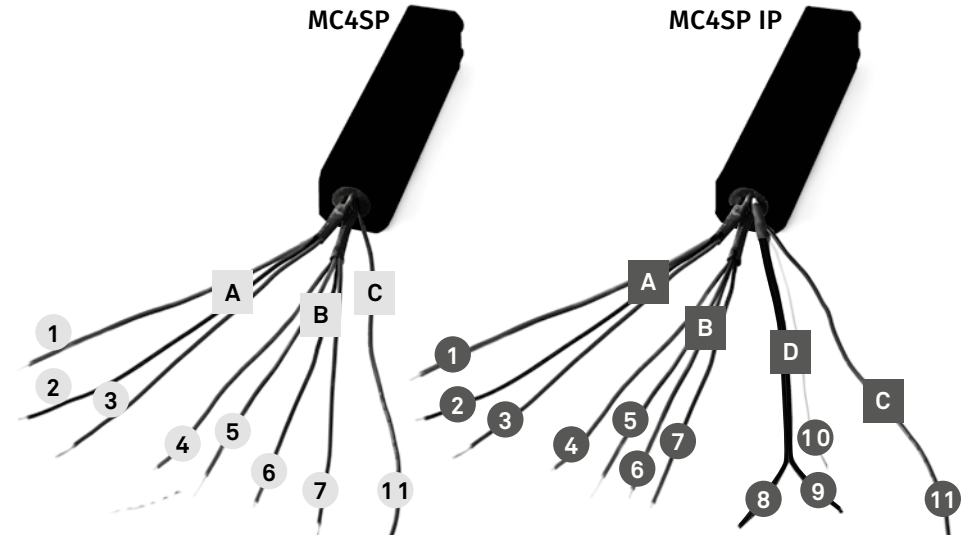

### • CONETORS DESCRIPTION

A	CN1: CENTRAL'S POWER SUPPLY CONNECTORS	C	
1	Blue - Line Input AC230V (neutral)	11	Antenna
2	Black - Line Input AC230V (phase)		
3	Ground Wire		

B	CN2: MOTOR'S CONNECTIONS	D	SWITCH
4	Black - Motor's Output AC230V (UP)	8	Black - Wire for switch - UP
5	Blue - Motor's Output AC230V (COMUM)	9	Black - Wire for switch - DOWN
6	Brown - Motor's Output AC230V (DOWN)	10	White - Common
7	Ground Wire		

## TECHNICAL SPECIFICATIONS

• Power Supply	230V AC   50-60Hz
• Motor's Output	230V AC 750W máx.
• Operating Temperature	-10° C a +65° C
• Frequency Transmission	433,92 Mhz
• Nº of Channels	6
• Code Type	Rolling Code
• Protection Level	IP44
• Dimensions	119X28X26mm

## CONNECTION DIAGRAM

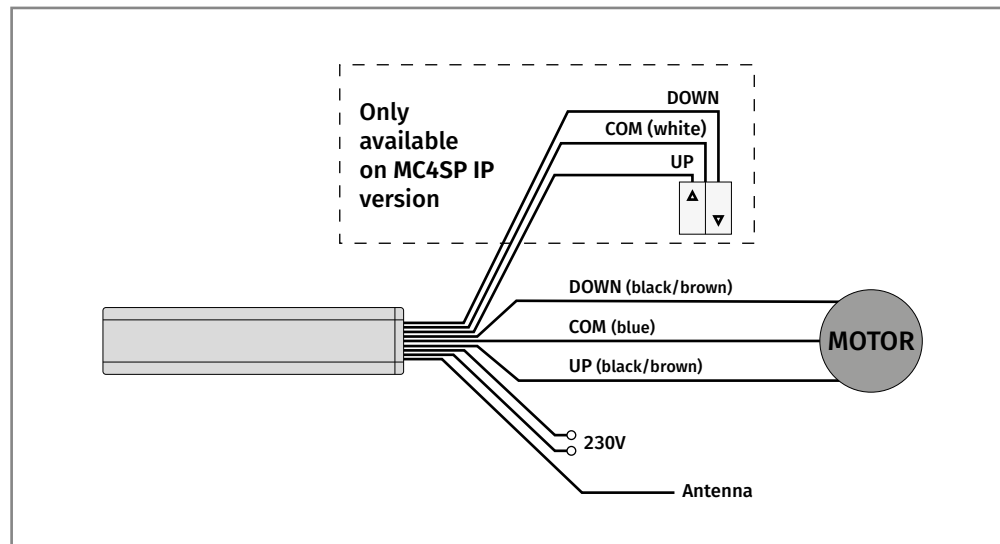

The control board MC4SP has capacity for 15 different controllers. Once out of memory, 4 beeps will signal that the memory is full. Start each the following settings with the central disconnected from the mains.

To know where is the location of the keys **OPEN**, **STOP** and **CLOSE** on the several radio-commands, check the following schemes:

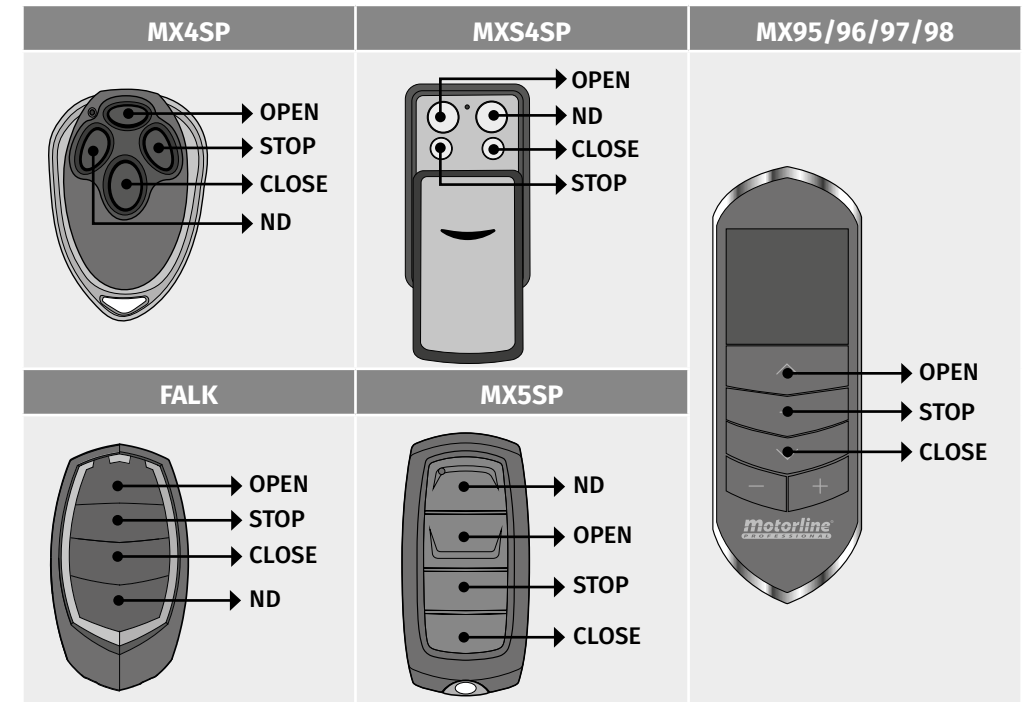

## PROGRAMMING

**WARNING:** Always start any programming with control board disconnected from the power supply!

### Programming new transmitter:



**01** • Continuously press the **OPEN** key transmitter to be programmed.

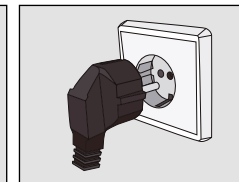

**02** • Connect the control board to a 230V power supply.

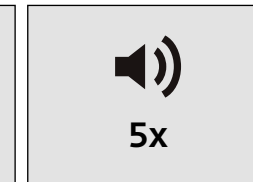

**03** • Keep the **OPEN** key pressed for 10 seconds, during which the control board emits slow 5 beeps.

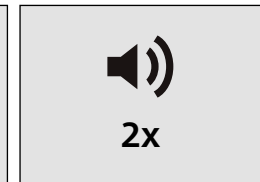

**04** • After 10 sec, the control board emits 2 quick beeps confirming the programming success.